

Slot/Tenon Soft Top Jaws

Page

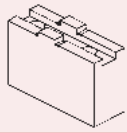

Standard Jaws

- For quick change jaw chucks • Steel • Aluminium

106 - 109

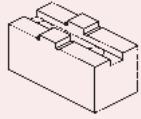

Large and Wide Jaws

- For quick change jaw chucks • Steel

106 - 109

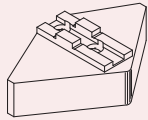

Diamond Jaws

- For quick change jaw chucks • Steel • Aluminium

106 - 109

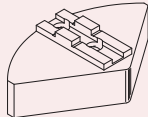

Segment Jaws

- For quick change jaw chucks • Steel • Aluminium

106 - 109

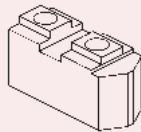

Standard Jaws

- For other slot/tenon power chucks

110

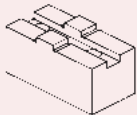

Standard and Large Jaws

- For chucks with American standard base jaws

110

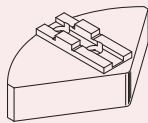

Segment Jaws

- For chucks with American standard base jaws

110

Slot/Tenon Soft
Top Jaws

	Std Jaws Steel and Aluminium	Large and Wide Jaws, Steel	Diamond Jaws Steel and Aluminium	Segment Jaw, Steel	Std Jaw other slot/tenon power chuck	American Std Soft Jaws, Steel
	Page	Page	Page	Page	Page	Page
BERG	106-109	106-109	106-109	106-109		
FORKARDT	106-109	106-109	106-109	106-109		
GAMET	106-109	106-109	106-109	106-109		
KITAGAWA	106-107	106-107	106-107	106-107		
RÖHM	106-109	106-109	106-109	106-109	110	
SAMCHULLY	106-109	106-109	106-109	106-109		
SCHUNK	106-109	106-109	106-109	106-109		
SMW-AUTOBLOK	106-109	106-109	106-109	106-109		
AMERICAN (ASA B5.8)						110

THAME WORKHOLDING

Field End, Thame Road, Long Crendon, Aylesbury, Bucks, HP18 9EJ England
 Telephone: + 44 (0)1844 208050 Fax: + 44 (0)1844 201699
 E-mail: sales@thameworkholding.com Web: www.thameworkholding.com

Slot/Tenon Soft Top Jaws

For Quick Jaw Change Chucks

Material

- Steel: 080M15 (En32) • Black Finish
- Aluminium: HE30TF • Natural Finish

Chuck Ø 140mm - 330mm

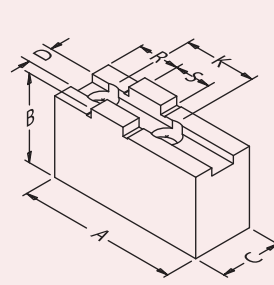

TYPE: GS - STEEL GA - ALUMINIUM

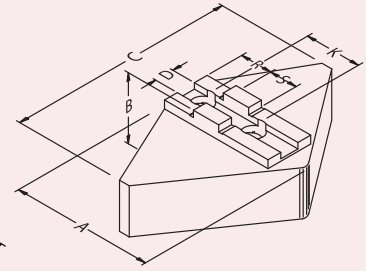

TYPE: HS - STEEL HA - ALUMINIUM

Slot/Tenon Soft Top Jaws

THAME PART No.	JAW TYPE	A	B	C	D	K	R	S	BOLT	WEIGHT Kg/Set
CU 14	GS	69	40	20	8	32	25	18	M8	0.9
CU 141	GS	63	45	30	8	32	19	18	M8	1.7
CU 16	GS	85	40	20	8	32	25	18	M8	1.1
CU 161	GS	85	55	30	8	32	19	18	M8	2.6
DP 16	GS	60	40	40	8	32	17	18	M8	1.8
CU 163	GS	70	60	40	8	32	19	18	M8	3.3
CW 16	GA	85	51	25	8	32	25	18	M8	0.7
CQ 16	HS	60	60	120	8	32		18	M8	9.0
HT 16	HA	62	64	120	8	32		18	M8	3.8
CF 16	IS	73	51	152Ø	8	32		18	M8	7.0
CU 20	GS	105	51	22	10	40	34	20	M8	2.2
CU 201	GS	100	55	30	10	40	23	20	M8	2.9
DP 20	GS	70	40	40	10	40	22	20	M8	2.2
CU 204	GS	85	60	40	10	40	23	20	M8	4.0
CU 205	GS	95	80	40	10	40	23	20	M8	5.8
CW 20	GA	105	51	25	10	40	34	20	M8	0.9
CQ 20	HS	89	64	150	10	40		20	M8	14.0
HT 20	HA	75	64	150	10	40		20	M8	5.9
CF 20	IS	90	51	203Ø	10	40		20	M8	11.0
CU 25	GS	125	55	30	12	40	36	20	M12	3.6
CU 251	GS	90	60	40	12	40	26	20	M12	3.9
CU 252	GS	125	60	40	12	40	26	20	M12	5.8
CU 253	GS	125	80	40	12	40	26	20	M12	7.5
CU 254	GS	125	100	40	12	40	26	20	M12	9.6
CU 255	GS	125	125	40	12	40	26	20	M12	12.0
DP 25	GS	90	60	60	12	40	26	20	M12	6.2
CU 257	GS	90	60	80	12	40	26	20	M12	8.5
CW 25	GA	125	60	40	12	40	36	20	M12	2.0
CQ 25	HS	102	64	170	12	40		20	M12	20.0
HT 25	HA	102	64	170	12	40		20	M12	8.4
CF 25	IS	123	51	254Ø	12	40		20	M12	17.0

THAME WORKHOLDING

Field End, Thame Road, Long Crendon, Aylesbury, Bucks, HP18 9EJ England
 Telephone: + 44 (0)1844 208050 Fax: + 44 (0)1844 201699
 E-mail: sales@thameworkholding.com Web: www.thameworkholding.com

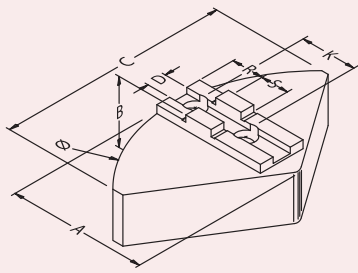

TYPE: IS - STEEL

BERG	FORKARDT	GAMET	KITAGAWA	RÖHM	SAMCHULLY	SCHUNK	SMW-AUTOBLOK
KHNC 140				DURO NC 140 DURO NC 168			KNCS 140 KNCS 140-32 KNCS-N 140-35
KHNC 160 KHNC 185	F160 KTNC 160 KTNCV 175 KTNCV 160 FNC 175 F+160	MX 152 MX 175		DURO 160 DURO NC 160 DURO NCE 160 DURO NC 175 DURO NCE 175 DURO NCES 175	QJC-206	ROTA-G 160 ROTA-S 160 ROTA-S plus 160 ROTA NC-W 185 THW 165R ROTA THW 165 ROTA NCR 200 ROTA THW plus 165 ROTA THW plus 185	RMG 160 HG 160 HG-F 160 HG-N 160 KNSP 160 KNCS 160 KNCS 175 KNC 160 KNCS 170-43 KNCS-N 170-43
KHNC 200	F 200 KTNC 200 KTNCV 200 FNC 200 F+200	MX215	QJ 8	DURO 200 DURO NC 200 DURO NCE 200 DURO NC 225 DURO NCES 200	QJC-208	ROTA-G 200 ROTA-S 200 ROTA-S plus 200 ROTA NC-WF210 ROTA NC-W 225 THW 210 F THW210R ROTA THW plus 215 ROTA THWB 210 ROTA THW vario 215	RMG 200 HG-F210 HG 200 HG-N210 KNSP 200 KNCS 200 KNCS 225 KNCS 210-52 KNCS-N 210-52 KNCS-N 225-65 KNCS-NB 210
KHNC 250 KHNC 315	F 250 KTNC 250 KTNC 280 KTNC 315 KTNCV 250 KTNCV 315 UNC 250/315 FNC 250/315 F+250	MX 252 MX315 MX 330	QJ 10 QJ 12	DURO 250 DURO NC 250 DURO NCE 250 DURO NCE 315 DURO NCES 250 DURO NCES 315	QJC-210 QJC-212	ROTA-G 250 ROTA NC-WF 25C ROTA-S 250 ROTA-S plus 250 ROTA NC-W 265 ROTAG315 ROTA NC-W 315 ROTA NC-WF 315 THW 250F THW 250R THW 265F THW 265R THW 315R ROTA THW 250 -315 ROTA THW plus 260-315 ROTA THWB 265	RMG 250 KNCS 250 KNCS 260 KNCS 315 KNCS 260-71 KNCS 315-91 KNCS-N 260-72 KNCS-N 315-91 HG 250/315 HG-F 260/315 HG-N 260/315 KNCS-NB 260 KNCS-NB 315

THAME WORKHOLDING

Field End, Thame Road, Long Crendon, Aylesbury, Bucks, HP18 9EJ England
 Telephone: + 44 (0)1844 208050 Fax: + 44 (0)1844 201699
 E-mail: sales@thameworkholding.com Web: www.thameworkholding.com

Slot/Tenon Soft Top Jaws

For Quick Jaw Change Chucks

Material

- Steel: 080M15 (En32) • Black Finish
- Aluminium: HE30TF • Natural Finish

Chuck Ø 315mm - 800mm

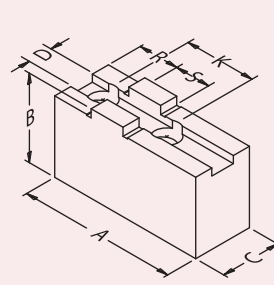

TYPE: GS - STEEL GA - ALUMINIUM

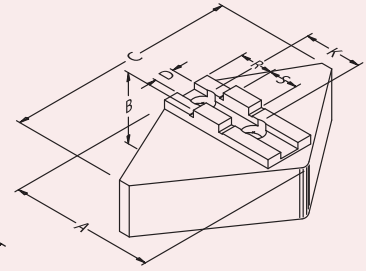

TYPE: HS - STEEL HA - ALUMINIUM

Slot/Tenon Soft Top Jaws

THAME PART No.	JAW TYPE	A	B	C	D	K	R	S	BOLT	WEIGHT Kg/Set
CU 32	GS	145	60	40	12	54	45	26	M12	6.8
CU 321	GS	110	60	40	12	54	30	26	M12	4.9
CU 323	GS	145	100	40	12	54	30	26	M12	11.1
CU 324	GS	145	125	40	12	54	30	26	M12	13.9
CU 325	GS	145	150	40	12	54	30	26	M12	16.9
CU 326	GS	110	60	60	12	54	30	26	M12	7.6
DP 32	GS	100	60	80	12	54	30	26	M12	8.4
CU 328	GS	110	80	80	12	54	30	26	M12	14.1
CU 329	GS	145	80	50	12	54	30	26	M12	11.6
CW 32	GA	145	60	40	12	54	45	26	M12	2.4
CQ 32	HS	132	76	240	12	54		26	M12	28.0
HT 32	HA	133	76	240	12	54		26	M12	10.5
CF 32	IS	148	51	305Ø	12	54		26	M12	23.0
CU 40	GS	180	80	50	18	60	50	30	M16	11.2
CU 401	GS	130	80	60	18	60	35	30	M16	11.9
CU 402	GS	180	80	60	18	60	35	30	M16	16.5
CU 403	GS	155	100	60	18	60	35	30	M16	15.3
CU 404	GS	155	125	60	18	60	35	30	M16	18.7
DP 40	GS	130	80	80	18	60	35	30	M16	16.2
CU 406	GS	155	160	50	18	60		30	M16	25.2
CW 40	GA	180	100	51	18	60	50	30	M16	6.3
CU 407	GS	155	80	80	18	60	35	30	M16	19.3
CU 50	GS	220	100	60	18	76	58	40	M16	28.5
CU 63	GS	260	125	60	24	82	70	40	M20	42.0

THAME WORKHOLDING

Field End, Thame Road, Long Crendon, Aylesbury, Bucks, HP18 9EJ England
 Telephone: + 44 (0)1844 208050 Fax: + 44 (0)1844 201699
 E-mail: sales@thameworkholding.com Web: www.thameworkholding.com

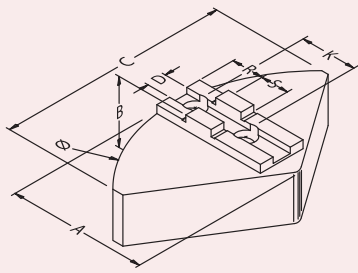

TYPE: IS - STEEL

BERG	FORKARDT	GAMET	KITAGAWA	ROHM	SAMCHULLY	SCHUNK	SMW-AUTOBLOK
KHNC 400	F 315 KTNC 360 KTNC 400 KTNCV 400 UNC 400 FNC 400 F+315	MX 380		DURO 315 DURO NC 315 DURO NCE 400 DURO NCES 315 DURO NCES 400	QJC-215	ROTA-G 400 ROTA-S315 ROTA-S plus 315 ROTA NC-W 400 THW 315F THW 400F THW 400R ROTA THWB 315	RMG-315 KNCS 400 KNCS 400-120 KNCS-N 400-128 HG 400 KNC 400 HG-N400 HG-F 315 KNCS-NB 400
KHNC 500	F 400/500L UNC 500 KTNC 500 KTNC 630 KTNCV 500 KTNCV 630 FNC 500/630 F+400			DURO 400 DURO NC 400 DURO 500 DURO NC 500 DURO NCE 500 DURO NCES 400		ROTA-S 400 ROTA-S plus 400 ROTA-G 500 ROTA-S 500 ROTA-S plus 500 THW 500F THW 500R THW 630R ROTA THW 500-630-800 ROTA THWB 400-500	HG 500 HG 630 HG-F 400/500 HG-N 500/600 KNCS 500 KNCS 630 KNCS 500-160 KNCS 630-160 KNCS-N 500-165 KNCS-N 630-165 KNCS 800-160 KNCS-NB 500-630-800
	F500S						
	F 630 F+630			DURO NC 630 DURO 630		ROTA-G 630 ROTA-S 630-800 ROTA-S plus 630-800	HG-F 630

THAME WORKHOLDING

Field End, Thame Road, Long Crendon, Aylesbury, Bucks, HP18 9EJ England
 Telephone: + 44 (0)1844 208050 Fax: + 44 (0)1844 201699
 E-mail: sales@thameworkholding.com Web: www.thameworkholding.com

Slot/Tenon Soft Top Jaws

Material :

- Steel: 080M15
- Black Finish

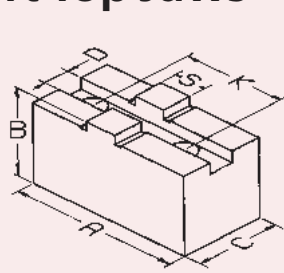

TYPE: GS- STEEL

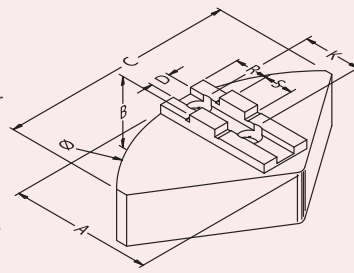

TYPE: IS- STEEL

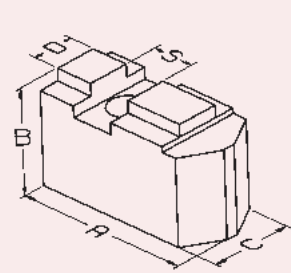

TYPE: HS- STEEL

To suit • Manual & Power Operated Chucks with American (ASA B5.8) & ISO 3442 Base Jaws

THAME PART No.	JAW TYPE	A	B	C	D	K	S	BOLT	WEIGHT Kg/Set	CHUCK Ø
DM 13	GS	56	40	20	6.35	22.2	9.5	M8	1.0	125Ø
DM 16	GS	74	40	25	7.94	38.1	12.7	M8	1.6	160Ø
DH 16	GS	74	60	25					2.4	
DF 16	IS	73	50	152Ø					7.0	
DM 20	GS	87	40	30	7.94	44.5	12.7	M8	2.2	200Ø
DH 20	GS	87	60	30					3.3	
DF 20	IS	97	50	203Ø					11.0	
DM 25	GS	103	50	35	12.7	54	19	M12	3.9	250Ø
DH 25	GS	103	80	35					6.2	
DF 25	IS	123	50	254Ø					17.0	
DM 32	GS	120	60	40	12.7	63.5	19	M12	6.0	315Ø
DH 32	GS	120	80	40					8.0	
DF 32	IS	148	50	305Ø					23.0	
DM 38	GS	137	70	40	12.7	76.2	19	M16	8.1	380Ø
DH 38	GS	137	100	40					11.6	
DM 46	GS	140	80	50	12.7	76.2	19	M20	12.5	460Ø
DH 46	GS	140	100	50					15.6	
DM 48	GS	152	80	60					13.6	

This jaw type is common to a large range of chuck manufacturers such as - Amestra, Autoblok, Bergmann, Bison, Buck, BTC, Cushman, Emco, Ladner, Pratt Burnerd, Rohm, Samchully, SCA, S.P., Strong, TdeG, TOS, Toolmex, plus many others.

To suit • Röhms KFD • Power Operated Chucks

THAME PART No.	JAW TYPE	A	B	C	D	K	S	P	BOLT	WEIGHT Kg/Set	TO SUIT CHUCK TYPE
DN 08	HS	40	30	22.5	8	-	8	3	M8	0.43	ROHM KFD 85
DN 09	HS	44.5	40	22.5	8	-	8	3	M8	0.70	ROHM KFD 95

Slot/Tenon Top Jaw and Chuck Data Sheet

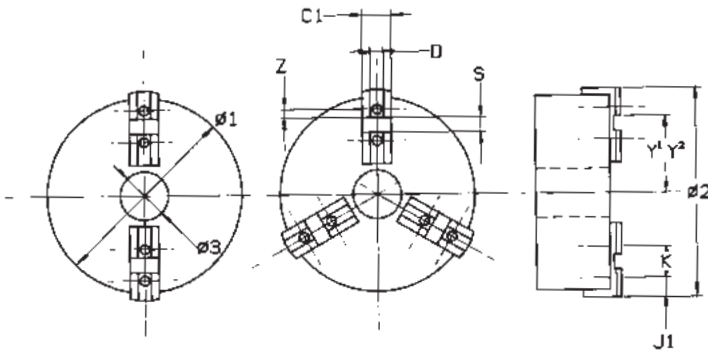

		2 JAW CHUCK DATA	3 JAW CHUCK DATA	REMARKS
Chuck Manufacturer / Model No.				
Chuck Ø / Type	ø1			
Maximum Swing Ø	ø2			
Chuck Bore	ø3			
Base Jaw Width	C1			
Chuck Centre To Rear Of Slot	Y1 max			
	Y2 min			
Thread	Z			
Centre Of Hole To Rear Of Base Jaw	J1			
Tenon Width	S			
Slot Width	D			
Tenon To Back Of Jaw	R			
Hole Centre Spacing	K			
Counterbore / Hole Ø	G/F			
Counterbore Depth	H			
Length Of Jaw	A			
Height (Inc. Tenon) Of Jaw	B			
Height Of Tenon	T			
Width Of Jaw	C			

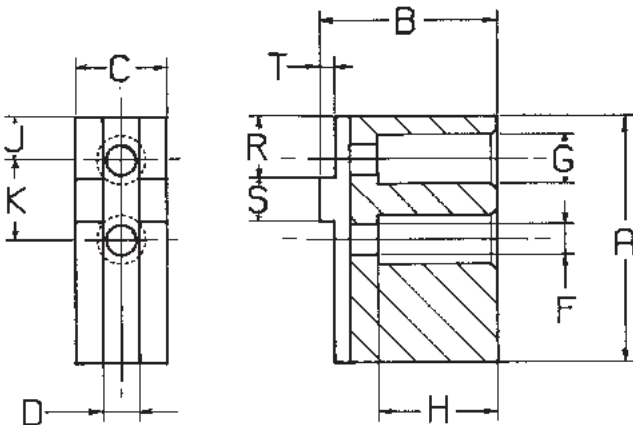

THAME WORKHOLDING

Field End, Thame Road, Long Crendon, Aylesbury, Bucks, HP18 9EJ England
 Telephone: + 44 (0)1844 208050 Fax: + 44 (0)1844 201699
 E-mail: sales@thameworkholding.com Web: www.thameworkholding.com